

WavStreamerTM Antenna

- Robust multi-band roof mount 5-in-1 MIMO antenna (2 x 4G / 2 x Wi-Fi / 1 x GPS)
- Environmentally tested & certified (SAEJ1455, AREMA, MIL-STD-810)
- Cables & connectors customized to meet your needs
- Manufactured In the U.S.A. backed by five-year STI-CO warranty



WavStreamer Applications



Freight / Passenger Rail



Transit / Bus



Public Safety

SPECIFICATIONS	STI-CO P/N: MRLP-XX-LLG22	COMMENTS
Frequency Range LTE 1 & 2 (MHz)	698-960 MHz 1700-2700 MHz	
Frequency Range WiFi 1 & 2 (MHz)	2400-2500 MHz 4900-5900 MHz	
GPS	GPS/Galileo/ GLONASS	Active Gain 28dB, 1.5-3.6V Supply Voltage Required
VSWR (max)	LTE ≤ 2.25:1 (698-960 MHz) LTE ≤ 2.0:1 (1700-2300 MHz) Wi-Fi ≤ 1.75:1 (2400-2500 MHz) Wi-Fi ≤ 2.0:1 (4900-5900 MHz)	Measured With 1FT
Isolation LTE 1 to LTE 2	≥ 7dB @ 700 MHz ≥ 5dB @ 755 MHz ≥ 6dB @ 800 MHz ≥ 11dB @ 900 MHz ≥ 20dB (1700-2300)	Measured With 1FT Cable
Isolation LTE 1 to WiFi	≥ 20dB (698-960 MHz) ≥ 10dB (1700-2300 MHz) ≥ 20dB (2400-2500 MHz) ≥ 20dB (4900-5900 MHz)	Measured With 1FT Cable
Isolation WiFi 1 to WiFi 2	≥ 25dB (2400-2500 MHz) ≥ 25dB (4900-5900 MHz)	Measured With 1FT Cable
Impedance (ohms)	50	
Connector	SMA-Female, Others Available	
Cable Type	LMR-195-FR (LTE 1&2) RG-174 (GPS) Customized Cable Length	LMR-195-FR is a non-halogen (non-toxic), low smoke, fire
Mounting Type (roof mount)	1" Dia. Feed Through 1.3" Long Threaded Boss For Up To 1/2" Thick Surface	
Radome Material	Makrolon Polycarbonate	
Dimensions	Length (in): 9.2" Height (in): 3.6" Width (in): 6"	
Thermal	SAEJ1455, 3/2017	
Operating Temperature Range	Operating: -40 °C to +75 °C Storage: -55° C to +85°C	
Vibration	SAEJ1455, 3/2017 AREMA, Part 11.5.1, 2008	
Mechanical	AREMA, Part 11.5.1,	
Salt Spray	SAEJ1455, 3/2017 AREMA, Part 11.5.1, 2008	
Water Ingress/ Pressure Wash	SAEJ1455, 3/2017	
Humidity Dust/Sand/Gravel	MIL-STD-810F SAEJ1455, 3/2017 AREMA, Part 11.5.1, 2008	

MIMO VSWR - ISOLATION MEASUREMENTS

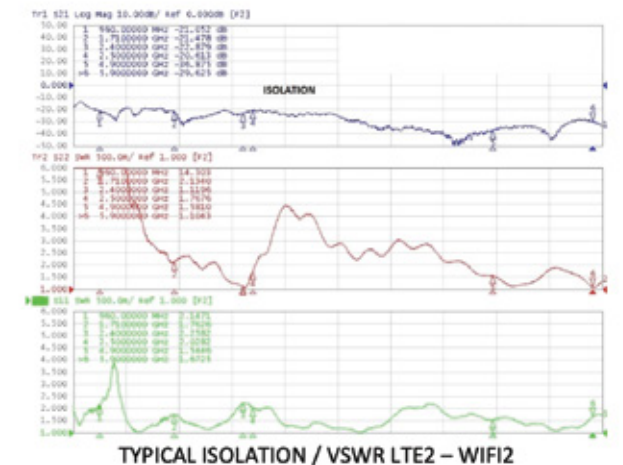
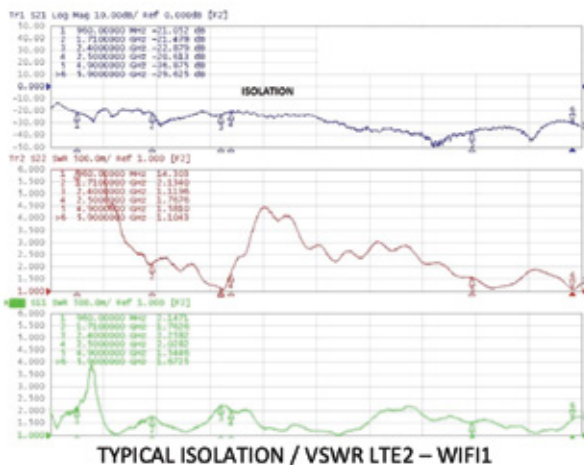
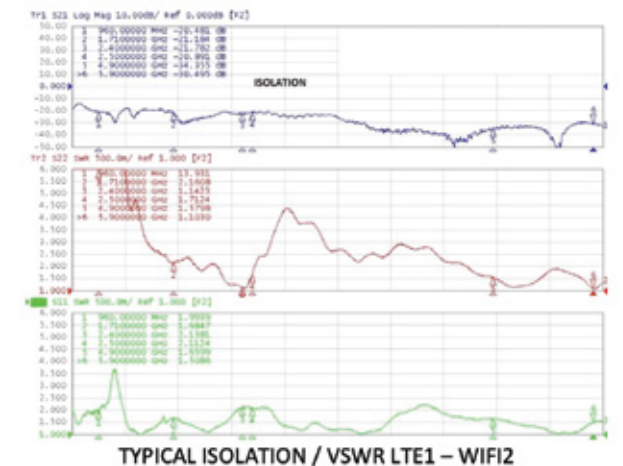
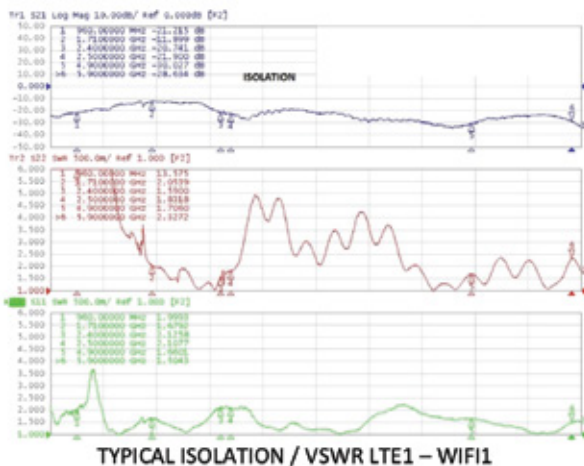
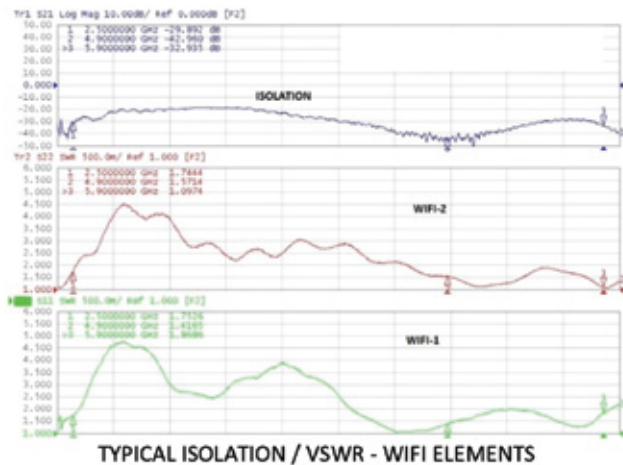
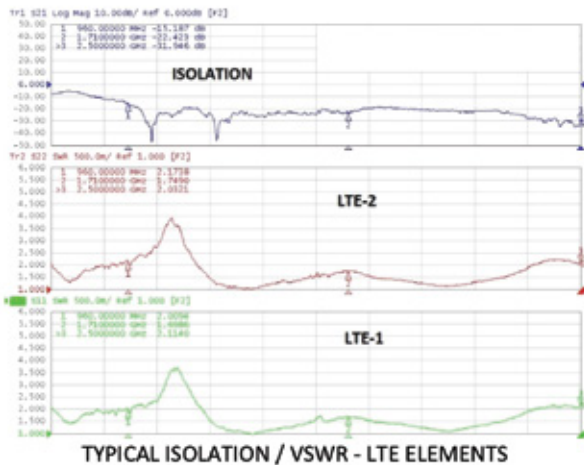

MIMO PEAK GAIN MEASUREMENTS

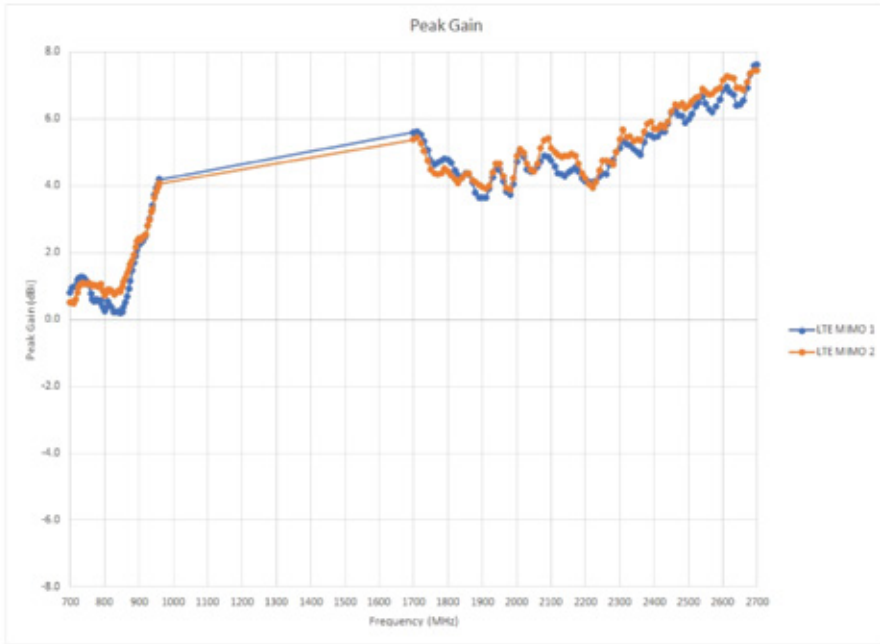

LTE MIMO PEAK GAIN

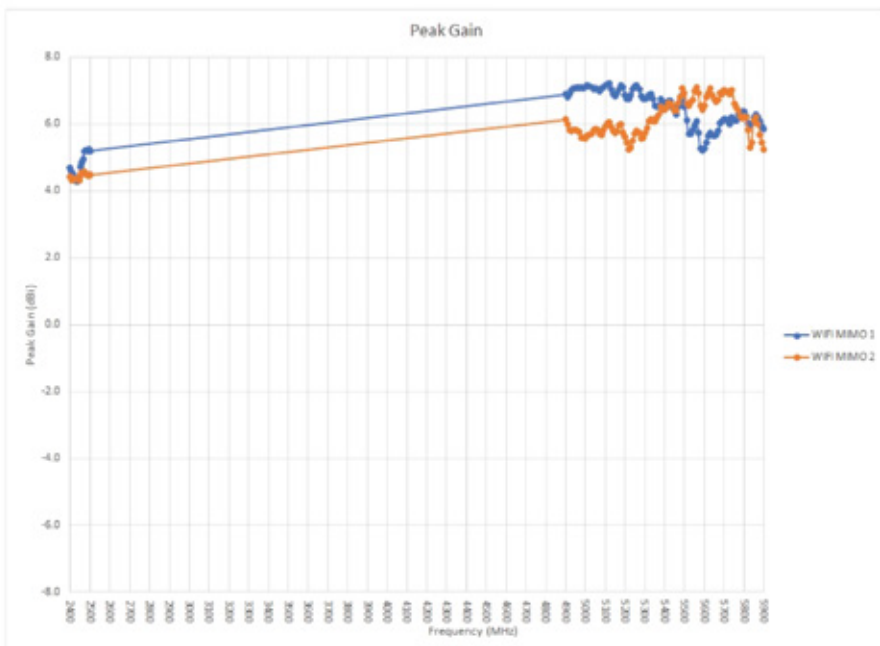

WiFi MIMO PEAK GAIN



CHAMBER SETUP

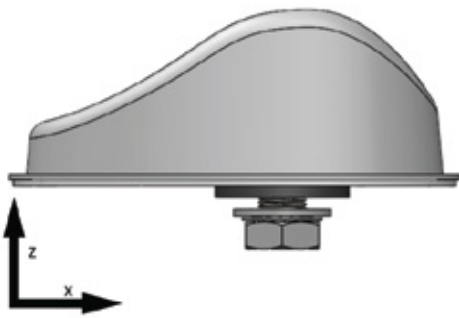
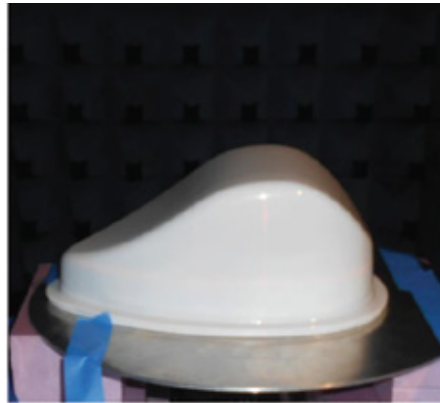

PHI=0 DEGREES

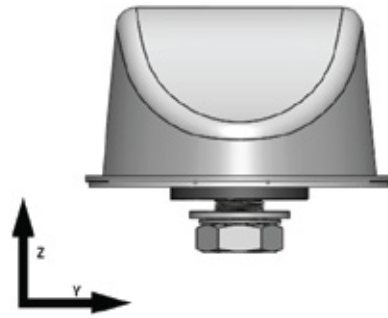

PHI=90 DEGREES

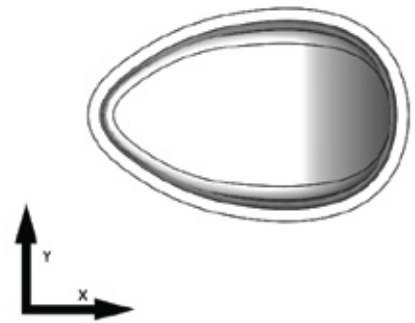

THETA=90 DEGREES

LTE MIMO 1 RADIATION PATTERNS

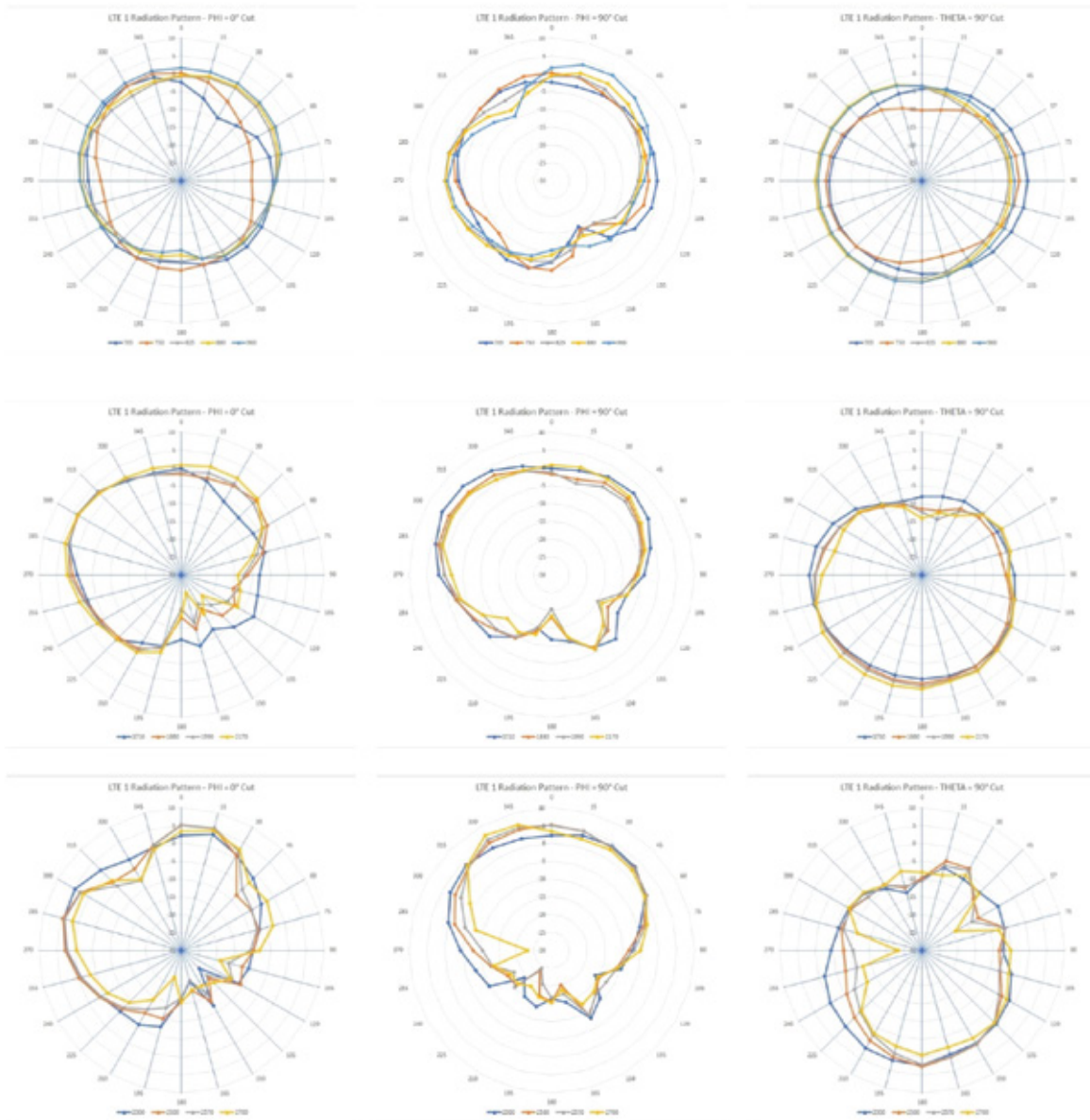

LTE MIMO 2 RADIATION PATTERNS

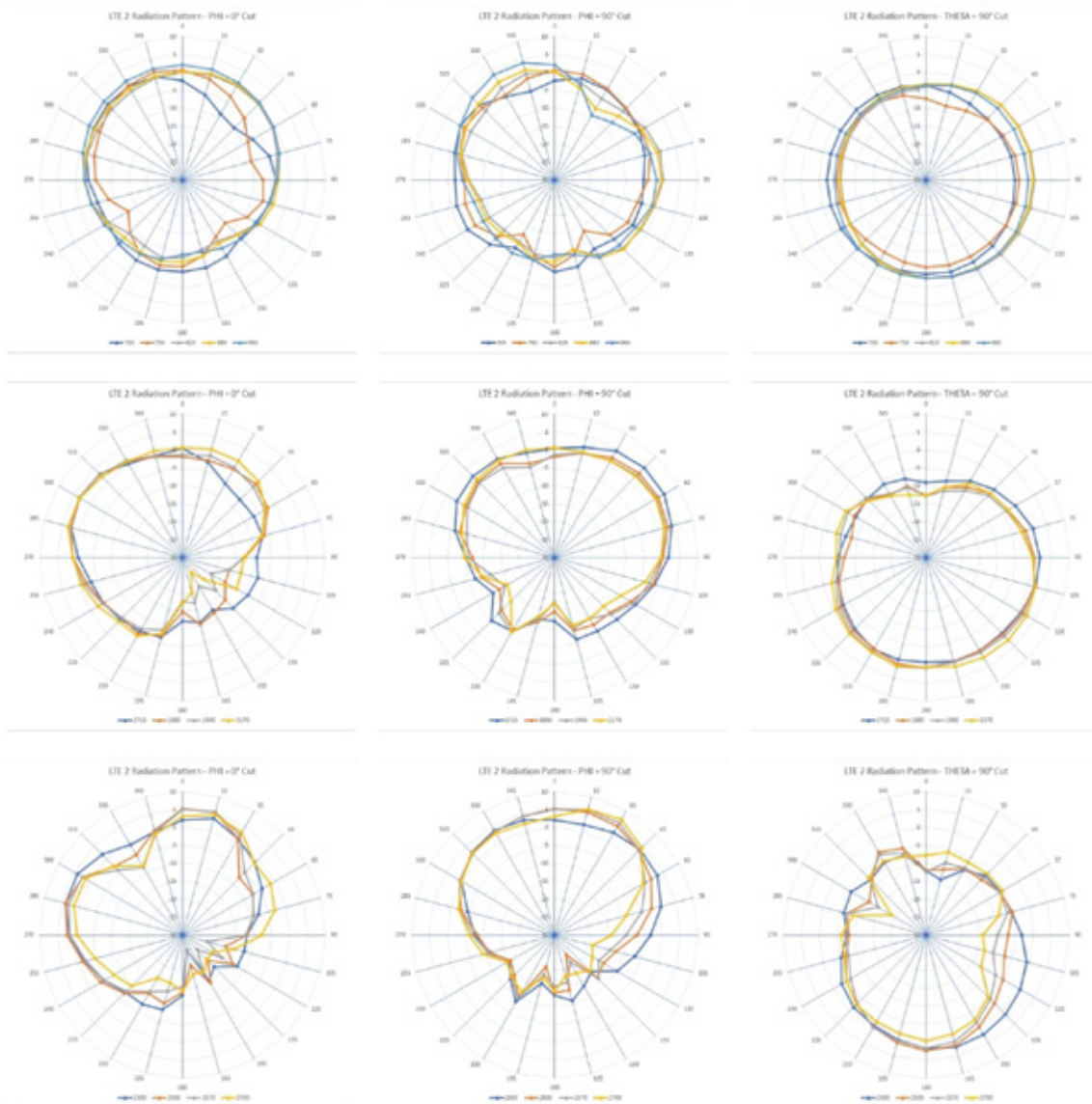

WIFI MIMO 2 RADIATION PATTERNS

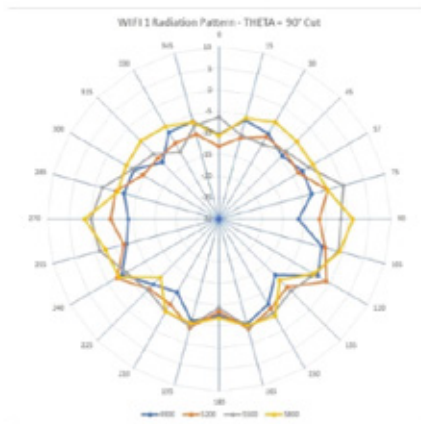
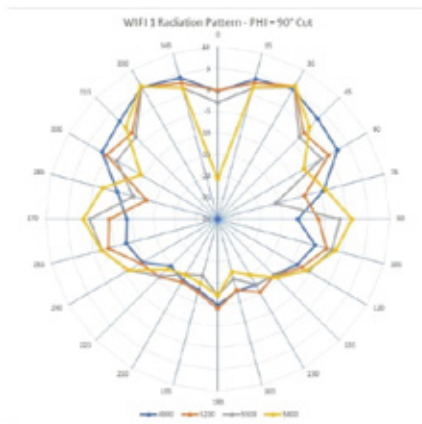
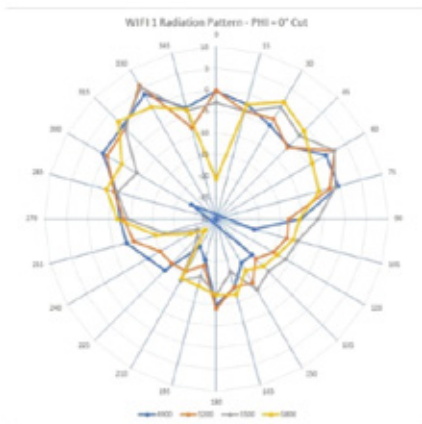
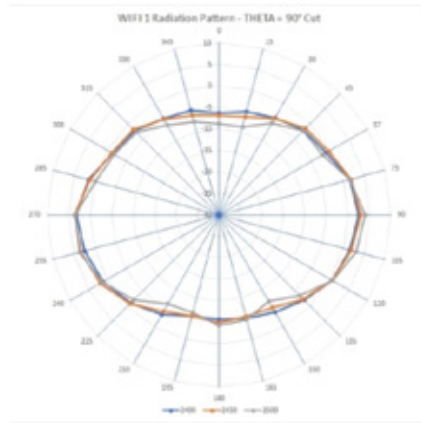
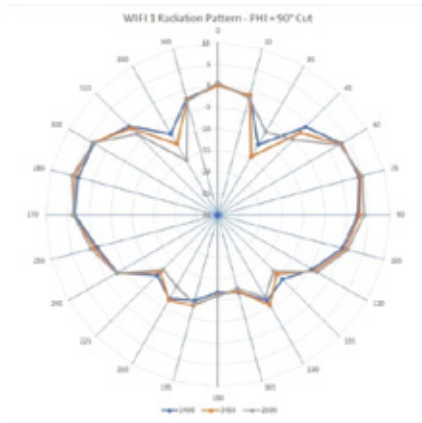
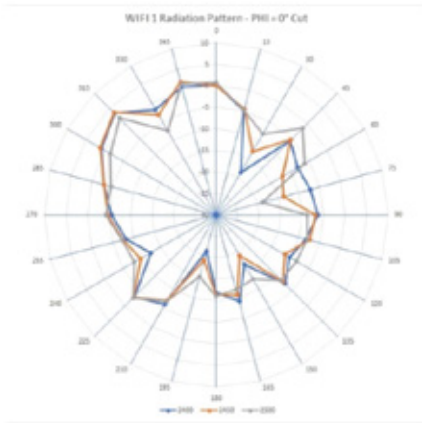

3D RADIATION PATTERNS

TYPICAL 3D PATTERN - LTE 1 850 MHZ

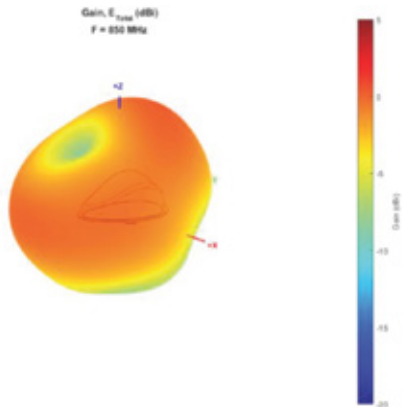

TYPICAL 3D PATTERN - LTE 2 850 MHZ

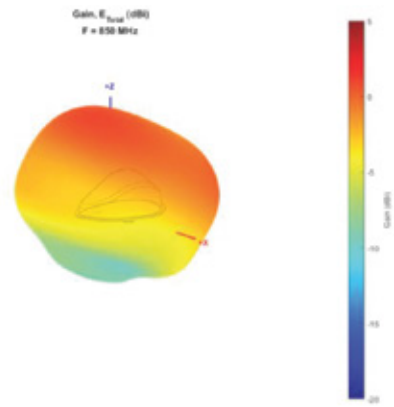

TYPICAL 3D PATTERN - LTE 1 1950 MHZ

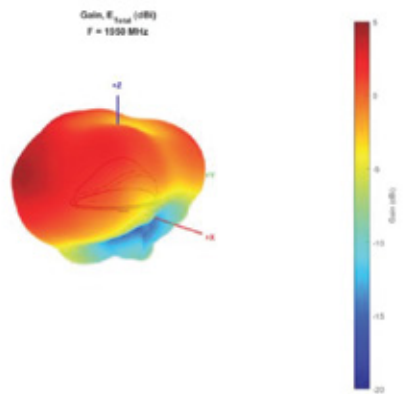

TYPICAL 3D PATTERN - LTE 2 1950 MHZ

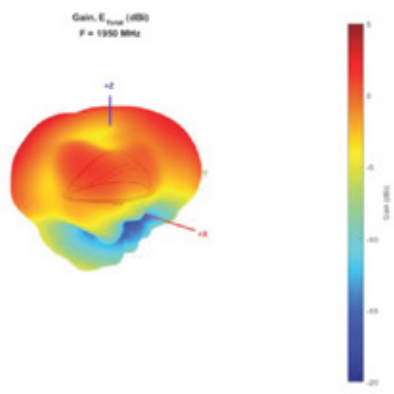

TYPICAL 3D PATTERN - LTE 1 2600 MHZ

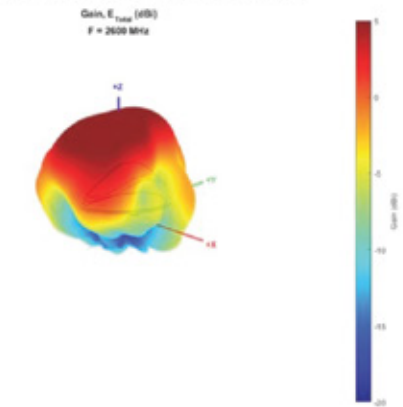

TYPICAL 3D PATTERN - LTE 2 2600 MHZ

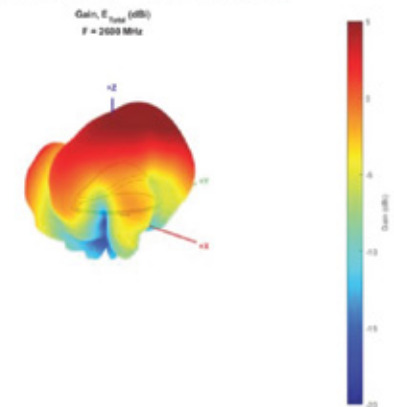

3D RADIATION PATTERNS

TYPICAL 3D PATTERN – WIFI 1 2440 MHZ

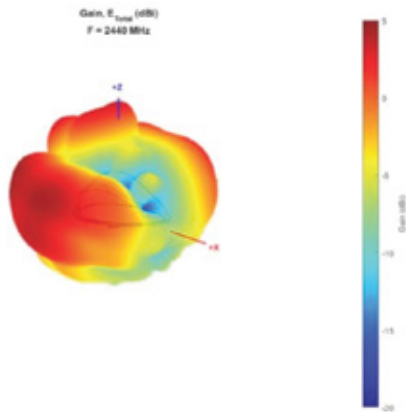

TYPICAL 3D PATTERN – WIFI 2 2440 MHZ

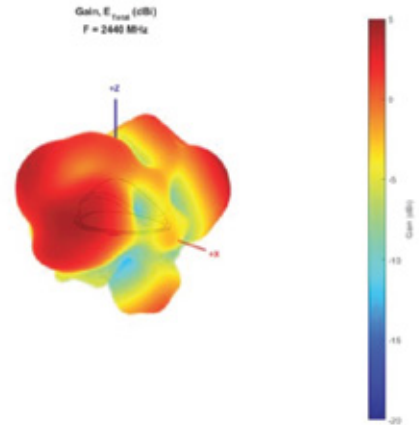

TYPICAL 3D PATTERN – WIFI 2 5400 MHZ

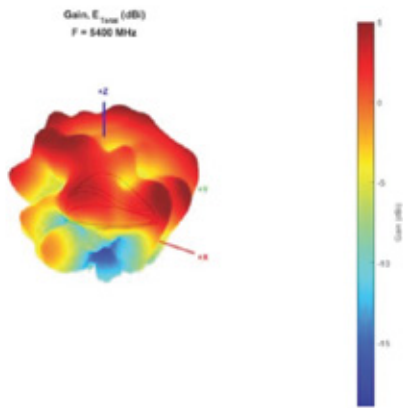

TYPICAL 3D PATTERN – WIFI 2 5400 MHZ

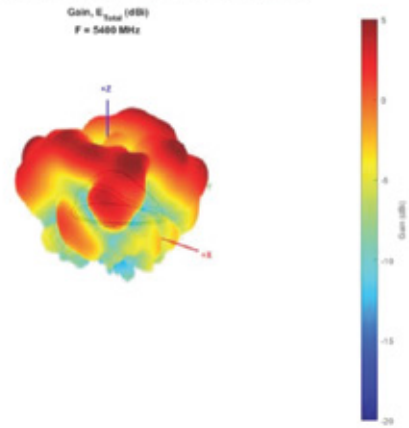

MECHANICAL DRAWING

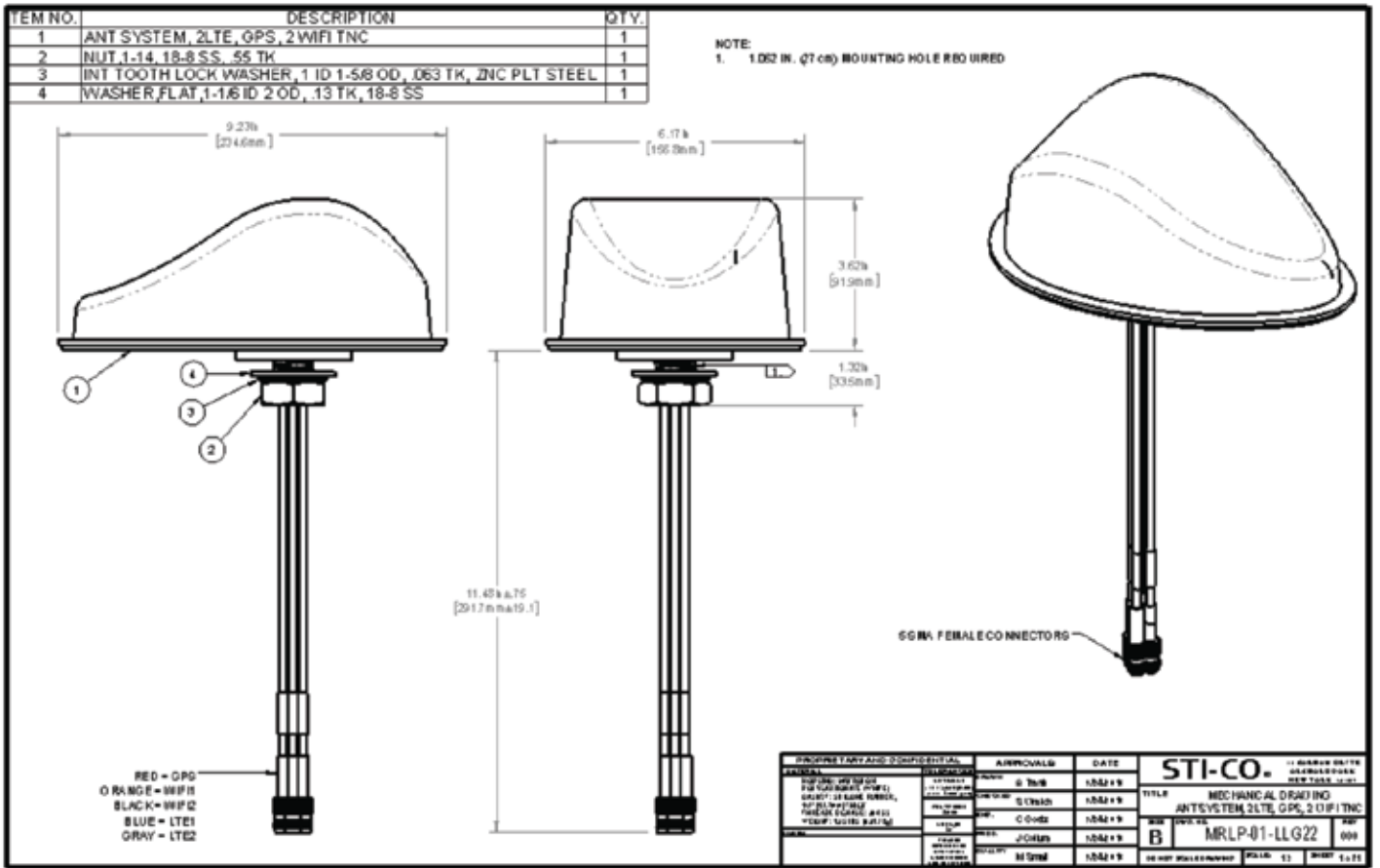

Wavstreamer Antenna Installation Considerations

Roof Mount Multi-Input/ Multi-Output Antenna

Model Number: MRLP-XX-LLG22

PLEASE VERIFY:

1. **Parts List:** This package consists of an antenna with attached cables and hardware. Use only the component supplied with the antenna system

INSTALLATION:

1. **Placement:** Select a desired location for the antenna on roof in a wide flat area. When mounting antenna on the roof, remember to allow room for the feedline. Drill 1-1/16" diameter hole. Remove any burrs above and below the hole.
2. **To install:** Insert RF cables and extension cables through the hole from outside of the vehicle. Be careful not to tear the cable's sheath when pulling it through sharp body panels.
3. **Assembly:** From bottom side of roof, install flat washer, internal tooth lock washer, and hex nut. Tighten to 10 ft-lbs using torque wrench and crow-foot wrench attachment, while holding antenna in position on top side of roof to prevent rotation of the antenna while tightening.
4. **Cables:** Attach cables to long-run cables per cooler codes and label

TESTING:

Installation testing if desired, must take place at the transmitter side of the feedline. Make sure all doors, the hood and trunk are closed.

1. **Reflected Power:** When measuring reflected power using a wattmeter, you can expect a maximum of 11%. If results are greater than 11%, recheck grounding.
2. **SWR:** A measurement of SWR (**S**tanding **W**ave **R**atio) should yield better than 2:1, recheck grounding.
3. **Continuity:** A test of continuity between the center pin and ground or body of connector of this antenna (each connector) will show as an open. This will ensure that the cable connectors and cables have the proper continuity.