



INSTRUCTION MANUAL

HF AUTOMATIC ANTENNA TUNER **AT-140**



This device complies with part 15 of the FCC rules. Operation is subject to the following two conditions: (1) This device may not cause harmful interference, and (2) this device must accept any interference received, including interference that may cause undesired operation.

FOREWORD

Thank you for purchasing the **AT-140 HF AUTOMATIC ANTENNA TUNER**.

The AT-140 is designed, primarily for use with Icom HF transceivers.

Refer to your HF transceiver instruction manual for operation. If you have any questions, contact your dealer.

IMPORTANT

READ ALL INSTRUCTIONS carefully and completely before using the AT-140.

SAVE THIS INSTRUCTION MANUAL. This instruction manual contains important safety and installation instructions.

EXPLICIT DEFINITIONS

WORD	DEFINITION
⚠ DANGER!	Personal death, serious injury or an explosion may occur.
⚠ WARNING!	Personal injury, fire hazard or electric shock may occur.
CAUTION	Equipment damage may occur.
NOTE	If disregarded, inconvenience only. No risk of personal injury, fire or electric shock.

PRECAUTIONS

⚠ DANGER HIGH VOLTAGE! NEVER touch the antenna terminal, ground terminal, antenna or counterpoise while transmitting. Place the AT-140, antenna and counterpoise in positions where no one can touch them.

⚠ WARNING! NEVER transmit during internal adjustment. This may cause an electric shock.

NEVER use without a ground connection.

USE the ground terminal for ground connection. The mounting plate is not connected internally.

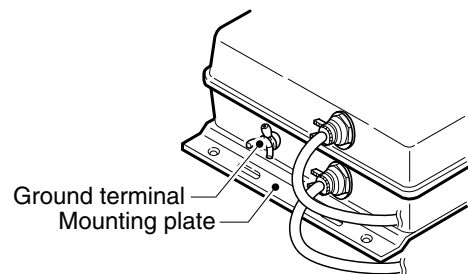

DO NOT operate your HF transceiver without running the vessel's engine. When the transceiver's power is ON and your vessel's engine is OFF, the vessel's battery will soon become exhausted.

DO NOT use the AT-140 in areas where the temperature is below -30°C (-22°F) or above $+60^{\circ}\text{C}$ ($+140^{\circ}\text{F}$).

SUPPLIED ACCESSORIES

The following accessories are supplied with the AT-140.

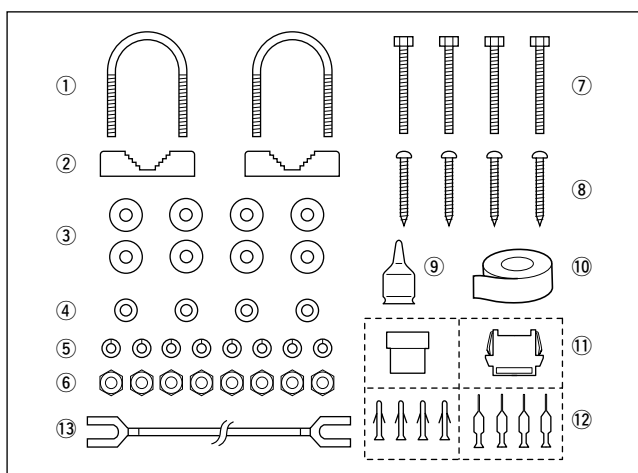

	Qty.
① U-bolts	2
② U-bolt plates	2
③ Flat washers (M6 large)	8
④ Flat washers (M6 small)	4
⑤ Spring washers (M6)	8
⑥ Nuts (M6)	8
⑦ Hex head bolts (M6x50)	4
⑧ Self-tapping screws (A0 6x30)	4
⑨ Weatherproof cap	1
⑩ Rubber vulcanizing tape	1
⑪ 4-pin/6-pin connector*	1
⑫ Connector pins*	4
⑬ Ground cable (OPC-412)	1

*The supplied pin connector and connector pins may differ, depending on the version.

MISCELLANEOUS ITEMS

The following parts are additionally required for installation, but are not supplied with the AT-140. Purchase these parts locally.

- ① AWG 14 × 4 conductor shielded cable
 - Icom offers an optional OPC-1147/N CONTROL CABLE. Length: 10 m (32.8 feet)
- ② 50 Ω coaxial cable
- ③ Two PL-259 connectors

FCC INFORMATION

This equipment has been tested and found to comply with the limits for a Class A digital device, pursuant to part 15 of the FCC Rules. These limits are designed to provide reasonable protection against harmful interference when the equipment is operated in a commercial environment. This equipment generates, uses, and can radiate radio frequency energy and, if not installed and used in accordance with the instruction manual, may cause harmful interference to radio communications. Operation of this equipment in a residential area is likely to cause harmful interference in which case the user will be required to correct the interference at his own expense.

 **CAUTION:** Changes or modifications to this transceiver, not expressly approved by Icom Inc., could void your authority to operate this transceiver under FCC regulations.

FEATURES

Weather resistant

The AT-140 is housed in a durable, completely weather resistant ASA case, with a rubber gasket. The antenna tuner can be conveniently installed near the antenna element.

Matches all bands

The AT-140 matches all frequencies on the HF marine band. For example, the tuner matches a 7 m (23 feet) long-wire antenna across 1.6–30 MHz.

Full automatic tuning

Just push the [TUNE] key on the transceiver, and the AT-140 immediately tunes for a minimum SWR on any frequency in the HF marine band.

HF operation on any size ship

The AT-140 allows HF operation where antenna element length is restricted due to space.

Simple installation

Installation is simple. Just connect the control and antenna cables. You never need to open the cover.

45 memories for shorter tuning time

To decrease the tune-up time, the AT-140 automatically stores the matching conditions for up to 45 frequencies. Retuning a memorized frequency takes approximately 1 second.

Super capacitor for memory backup

Even if the AT-140 is not used for approximately 1 week, the built-in super capacitor backs up the contents of the 45 memories.

Low power tune up

The AT-140 emits low output power during tuning. This feature reduces the possibility of causing interference to other stations.

Tuner Through function

The Tuner Through function is built into the AT-140. This function helps improve receiver gain, depending on the antenna element length used, and the operating frequency.

TABLE OF CONTENTS

FOREWORD	i
IMPORTANT	i
EXPLICIT DEFINITIONS	i
PRECAUTIONS	i
SUPPLIED ACCESSORIES	i
MISCELLANEOUS ITEMS	i
FCC INFORMATION	ii
FEATURES	ii
■ Five Critical Points for a successful HF installation.....	1
■ Vessel ground connection	1
SYSTEM INSTALLATION	1
■ Antenna and tuners.....	2
■ The importance of grounding	2
■ Antenna for ship	3
■ Antenna for land operation	3
ANTENNA SYSTEM	3
■ Coaxial cable	4
■ Ground and counterpoise	4
■ Installation outline	5
■ Control cable	5
INSTALLATIONS	5
■ PL-259 connector	6
■ Waterproofing the antenna connection	6
■ Mounting	7
■ Cable connections	7
CONTROL CABLE SIGNALS	8
■ Terminal information	8
■ Transceiver setting	9
UNIT DESCRIPTION AND SPECIFICATIONS ...	10
■ Unit description	10
■ Dimensions	10
■ Specifications	10
INSTALLATION EXAMPLE	11

Icom is not responsible for the destruction, damage to, or performance of any Icom or Non-Icom equipment, if the malfunction is because of:

- Force majeure, including, but not limited to, fires, earthquakes, storms, floods, lightning, other natural disasters, disturbances, riots, war, or radioactive contamination.
- The use of Icom antenna tuners with any equipment that is not manufactured or approved by Icom.

Icom and the Icom logo are registered trademarks of Icom Incorporated (Japan) in Japan, the United States, the United Kingdom, Germany, France, Spain, Russia, Australia, New Zealand, and/or other countries.

■ Five Critical Points for a successful HF installation

These critical points apply to almost any HF installation, whether it is for a base station, in a vehicle, or a marine vessel. For the best and most reliable communication capability, use them during the planning and installation of your HF system.

1. Install transceiver as close as possible to your vessel's operation location and to your power source, whether you are using batteries or an external power supply.
2. Install the antenna in an open location as far as possible from your operating station.
3. Install the antenna tuner in an **open location*** as close to the base of your antenna as possible.

4. Install copper straps or radial wires as your ground system. These will give you a good solid ground system, which is critical for reliable communications.
5. Make all your power source, control and coaxial cables as short as possible. Do not coil up any cables that are longer than they should or could be.

Following these rules will minimize marginal installations and problem sources such as RF feedback in the transceiver, power supply or cables and "hot" or RF burning microphones.

If all 5 above points are followed during the design and installation of your HF system, the operator can expect top performance.

*The AT-140 is housed in a durable, completely weather resistant case. You don't have to worry a lot about rain, splash, and so on.

■ Vessel ground connection

The HF system MUST have an adequate RF ground connection. Otherwise, the overall efficiency of the HF system installation will be reduced. Electrolysis, electrical shocks and interference from other equipment could also occur.

For best results, use 50 or 75 mm (2 or 3 inches) wide copper strap and make the connection as short as possible. Ground the HF system to one ground point, otherwise the voltage difference (in RF level) between 2 ground points may cause electrolysis.

⚠ **WARNING—** *When grounding to a metal hull*
Use Zinc anodes to protect the hull from electrolysis.

Ask your technical dealer, installer or refer to a technical book for RF grounding details.

⚠ **CAUTION: NEVER** connect the HF system to a "positive-grounded ship," otherwise it will not function.

Best ground points

- External ground plate
- Copper screen
- Copper foil

Acceptable ground point

- Stainless steel stanchion
- Through mast
- Through hull
- Metal water tank

Undesirable ground points

- Engine block
- Ship's DC battery ground

Unusable ground points

(these connections may cause an explosion or electrical shock)

- Gas or electrical pipe
- Fuel tank or oil-catch pan

Ground system example

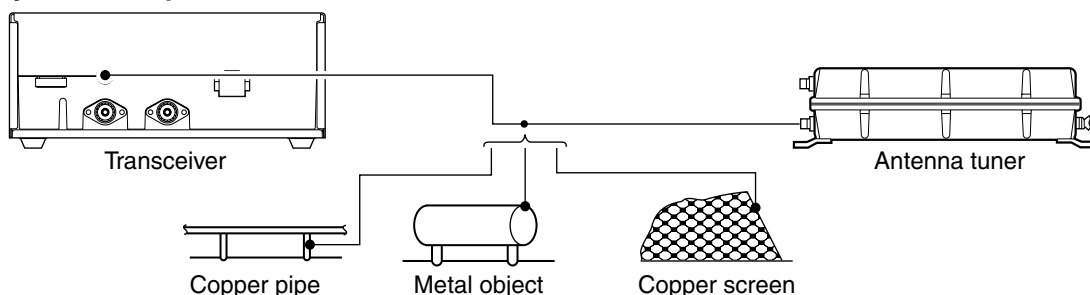

■ Antenna and tuners

If your Icom HF system is going aboard a sailboat, you may use an insulated backstay to make up your antenna system. Your best range will be from an insulated backstay because of the long length of the antenna element which is that portion between the top and bottom insulators. Have your rigger put the top insulator about at least 1 meter down from the tip of the mast. Have your rigger install the bottom insulator at about eye-level when you're standing back aft. (This length between insulators should not exceed 37 meters or be less than 7 meters.)

This non-resonant antenna can be tuned by the Icom automatic antenna tuner that matches your transceiver. The tuner is connected to the transceiver. We suggest you use "GTO-15" high voltage lead-in wire from the single wire output of the tuner to your insulated backstay. This high voltage wire won't break down in wet weather or sunlight. Use stainless steel hose clamps to attach the wire to the insulated backstay.

The tuner is fed with a coaxial and a control cable from the Icom transceiver.

Check with your dealer regarding antennas and cabling.

⚠ DANGER: HIGH VOLTAGE!

NEVER touch the antenna element while tuning or transmitting.

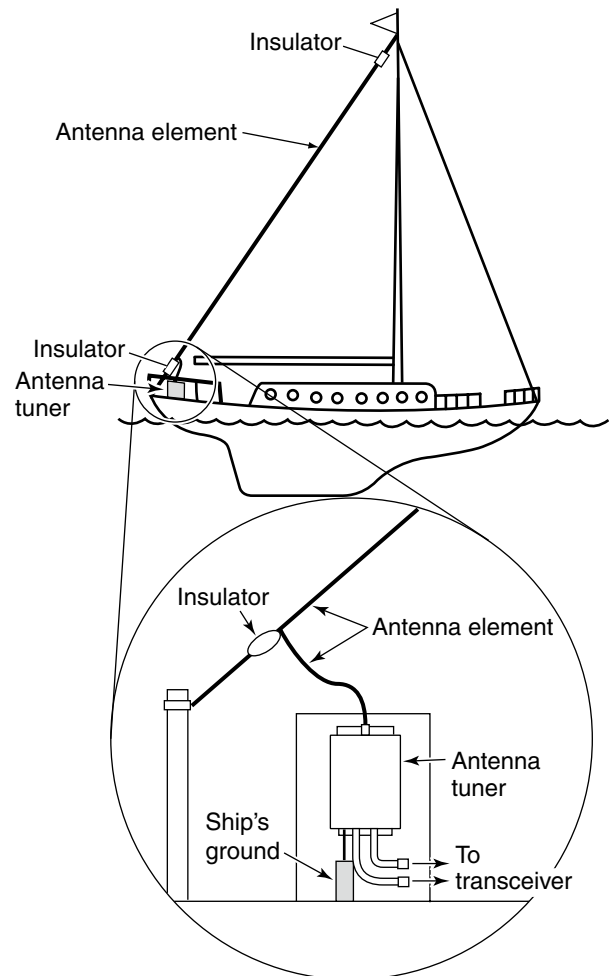

■ The importance of grounding

Surface area to the sea water and the use of copper foil exclusively throughout your RF ground system is the combination that gives you reliable long range communications. The sea water gives your signal a solid surface to push off from. This is called a "counterpoise," and it's the necessary "other-half" of your antenna system that must be achieved for your overall HF transceiver system to work well.

■ Antenna for ship

◇ Required antenna element length

Required antenna element length to achieve full performance varies, according to the lowest frequency.

The lowest frequency	Required antenna element length
1.6 MHz band	7 m (23.0 feet) or longer
4 MHz band	3 m (9.8 feet) or longer

The longer the antenna element, the longer communication distance.

◇ Undesirable antenna element lengths

DO NOT use an antenna element such as multiples of $\frac{1}{2}\lambda$ lengths (half wavelength), since tuning becomes difficult.

L : Undesirable antenna element length [m]

f : Operating frequency [MHz]

n : Natural number (n = 1, 2, 3, ...)

$$L = \frac{300}{f} \times \frac{1}{2} \times n$$

[Example]

At an operating frequency of 16 MHz, avoid the following antenna element lengths:

$$L = \frac{300}{16} \times \frac{1}{2} \times n \approx 9.4, 18.8, \dots$$

$$1 \text{ m} \approx 39 \text{ inches}$$

For example, if 15 m (49.2 feet) is selected for an antenna element length, you have no problem in the 1.6 to 25 MHz marine bands range.

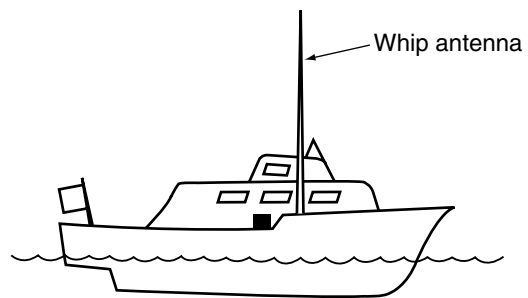
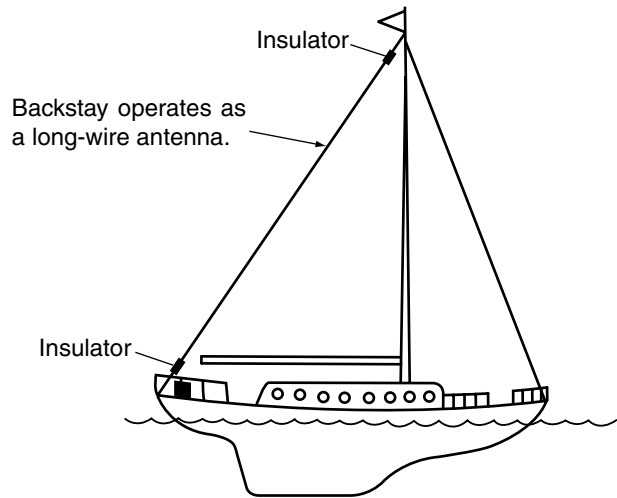

NOTE: Keep antennas as far away from other objects as possible, especially metal objects.

■ Antenna for land operation

In some countries, HF transceivers can be used for land mobile operation. Ask your Icom Dealer for details, since the radio law varies according to each country.

For land mobile operation on 4 MHz or above, an optional AH-2b ANTENNA ELEMENT is available. The AH-2b includes a sturdy tow hook mount system for holding a 2.5 m (8.2 feet) stainless steel antenna element plus all the necessary hardware.

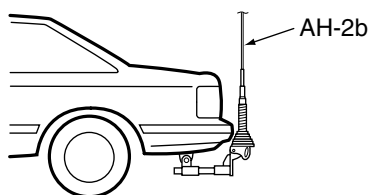

Refer to the AH-2b instruction manual for the AH-2b and AT-140 installation to your vehicle. Ask your Icom Dealer for details.

Connect a suitable antenna element for a base station. To achieve full performance, refer to "Required antenna element length" as described above.

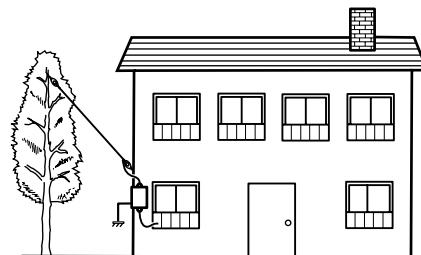

■ Coaxial cable

Insulate the lead-in cable of the AT-140 antenna terminal and antenna element from other metal objects.

To prevent interference, keep cables as far as possible from an antenna, electric pump and other electronic equipment.

To prevent erroneous indications, keep cables as far away as possible from the flux gate compass.

Use suitable noise filters for alternators or fluorescent lights. Ask your dealer for details.

■ Ground and counterpoise

◇ Why a ship's ground is required

The AT-140's ground terminal **MUST** be connected to your ship's ground. Grounding prevents electric shocks, interference to other equipment and other problems. The AT-140 does not properly operate without the grounding connections.

⚠ **DANGER! NEVER** connect the ground terminal to the following points. These connections may cause an explosion or electric shocks:

- Gas or electrical pipe
- Fuel tank or oil-catch pan

IMPORTANT: The mounting plate is **NOT** connected to the AT-140's internal ground.

◇ Ideal ground points

One of following points is ideal:

- Ship's ground
- External ground plate
- External copper screen/foil

◇ Good ground points

If electrically connected to sea water, one of the following points is usable:

- Stainless steel stanchion
- Through mast
- Through hull
- Metal water tank

◇ Undesirable ground points

These connections may cause noise or electrolysis:

- Engine block
- Ship's DC battery ground

◇ Electrolysis

All ground cables from the AT-140 or HF transceiver on your ship should be connected to only one ship's ground.

DO NOT connect to two or more points. Voltage difference between two or more ship's grounds may cause electrolysis.

DO NOT connect between dissimilar metals where an electric current is present. These connections may cause electrolysis.

◇ Counterpoise

If your ship is made of FRP, etc. and a good ship's ground is not available, connect a counterpoise.

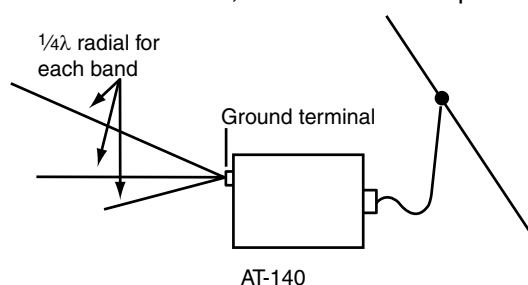

$\frac{1}{4}\lambda$ (quarter wavelength) radial for each band is suitable for a counterpoise. Install the counterpoise directly below the AT-140's ground terminal. Insulate the ends of each radial from other metal objects. Layout the radial horizontally and as straight as possible.

L : Counterpoise length for the operating frequency [m]

f : Operating frequency [MHz]

$$L = \frac{300}{f} \times \frac{1}{4}$$

[Example]

At an operating frequency of 16 MHz, use a counterpoise with the following length:

$$L = \frac{300}{16} \times \frac{1}{4} \approx 4.7 \text{ [m]}$$

1 m \approx 39 inches

Ground cable

For best results, use the heaviest gauge wire or metal strap. Make the distance between the AT-140's ground terminal and ship's ground as short as possible.

The supplied ground cable can be used for ground connection through a mast. Confirm that the mast is electrically connected to sea water.

⚠ **WARNING!—** *When grounding to metal hull* Use a Zinc anode to protect the hull from electrolysis. Ask your technical dealer or installer, or refer to a technical book for RF ground details.

Installation outline

- ① Connect the pins to the control cable and insert into the supplied connector.
 - Refer to "Control cable" as described below.
- ② Connect and solder the PL-259 connector to the coaxial cable.
 - Refer to page 6, "PL-259 connector."
- ③ Mount the AT-140 in the desired location.
 - Refer to page 7, "Mounting."
- ④ Connect the control and coaxial cables between the transceiver and the AT-140.
 - Refer to page 7, "Cable connections."
- ⑤ Connect the AT-140's ground terminal to the ship's ground or counterpoise.
 - Refer to page 3 "Antenna for ship," and page 4 "Ground and counterpoise."
- ⑥ Connect the antenna element (wire).
 - Refer to examples on pages 2, 11 and 12.

Control cable

Between the AT-140 and HF transceiver, connect four control signal lines, as shown below. To prevent RF feedback, use a four conductor shielded cable. Connect the shield line to the [GND] terminal on the transceiver.

Icom offers 10 m (32.8 feet) long control cables.

OPC-566: for IC-M710/RT, M700PRO

OPC-1147/N: for IC-M802

Refer to page 8, "Terminal information" for details.

When connecting to Icom IC-M802

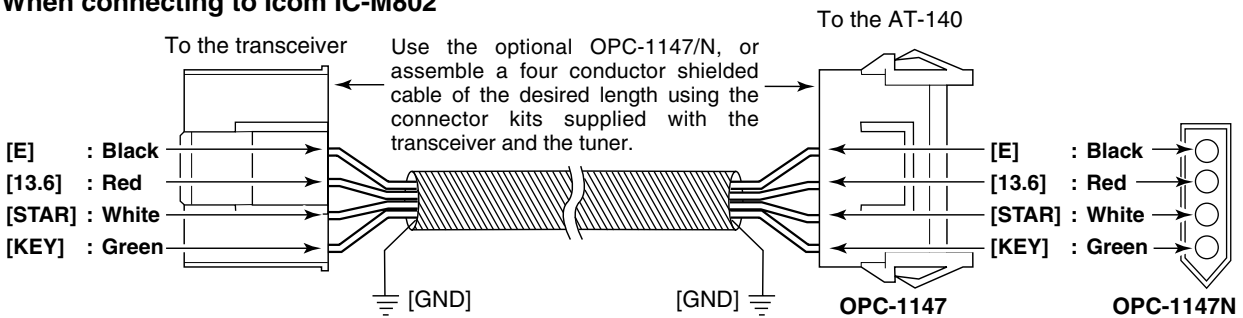

When connecting to Icom IC-M710/RT, IC-M700PRO

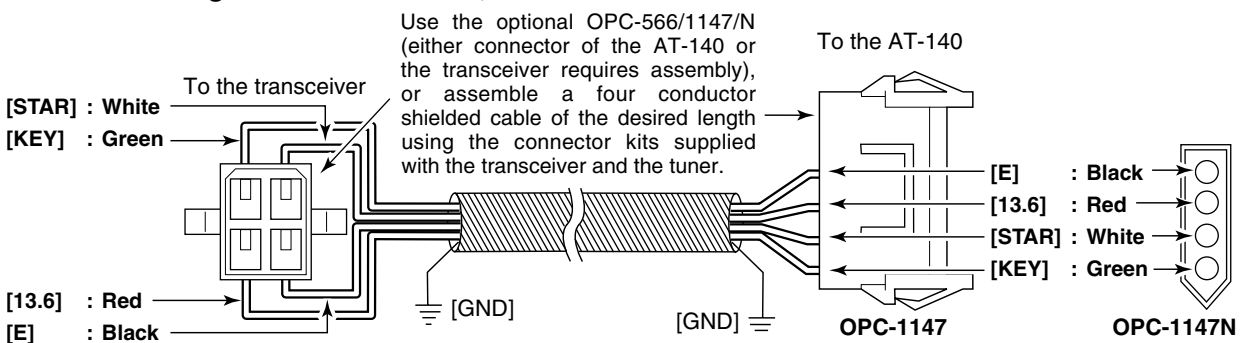

When connecting to Icom IC-M700/TY, IC-78

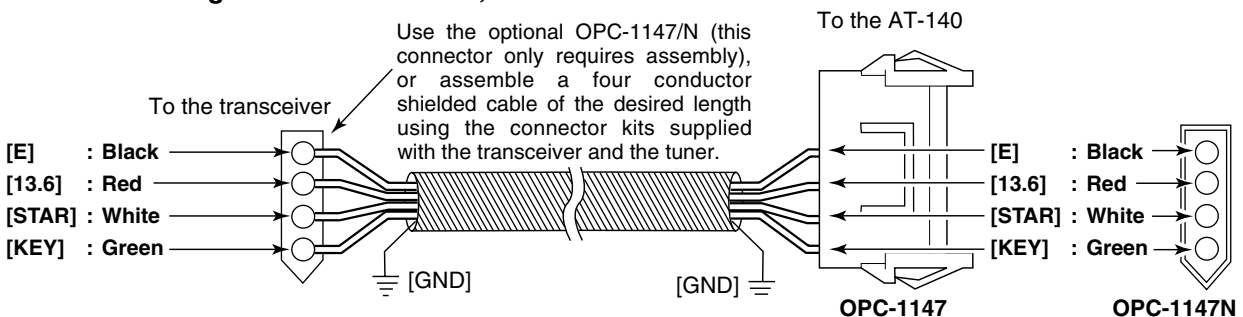

■ PL-259 connector

① Slide the coupling ring down.
Strip the cable jacket and tin the shield.
• Tin the exposed braid and then pull out the jacket.

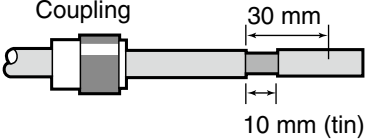

② Strip the cable as shown below.
Tin the center conductor.

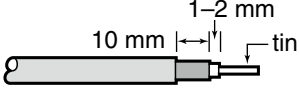

③ Slide the connector body over the cable and solder it.

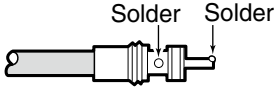

NOTE: Use a soldering iron with enough heating power to securely solder the ground braid and body. Otherwise the connection may be loose, and communication trouble may occur.

④ Screw the coupling ring onto the connector body.

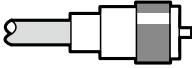

30 mm (1.2 inches) 10 mm (0.4 inches) 1-2 mm (0.04-0.08 inches)

■ Waterproofing the antenna connection

CAUTION: If you skip the following steps, moisture will get into the connector, and this could damage the antenna tuner.

① Cut off just the top of the weatherproof cap, and pass the antenna wire through the cap.

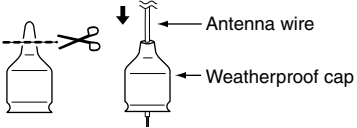

② Insert the antenna wire into the opening of the crimp-on wire terminal.
• Crimp or solder the antenna wire.

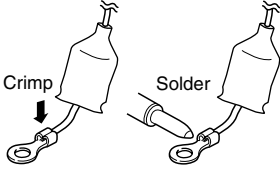

③ Put the crimp-on wire terminal, star washer, and wing nut on the base nut, in that order, then, tighten the wing nut.
• Make sure the base nut is tightened firmly, before you tighten the wing nut. (See the Fig.1 to the right.)
• Carefully bend the wire terminal up, after you tighten the wing nut. (See the Fig.2 to the right.)

Fig.1

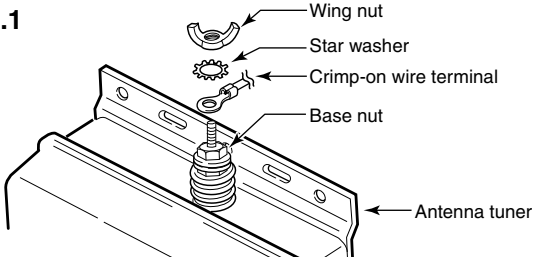

④ Place the weatherproof cap over as much of the insulator as possible.
• How far down it will go depends on the height of the wing nut.

⑤ Start wrapping the rubber vulcanizing tape at the bottom of the insulator, then the weatherproof cap and finally the antenna wire to prevent water seeping.
• Wrap electrical tape* over the rubber vulcanizing tape to secure waterproofing.
* The electrical tape is not supplied with the AT-140.

Fig.2

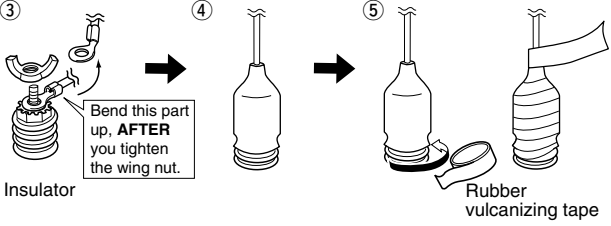

Insulator

Rubber vulcanizing tape

Bend this part up, AFTER you tighten the wing nut.

■ Mounting

CAUTION: Mount the AT-140 in a horizontal position or in a vertical position with the antenna terminal up.

◇ Mounting on a Mast/Metal pole

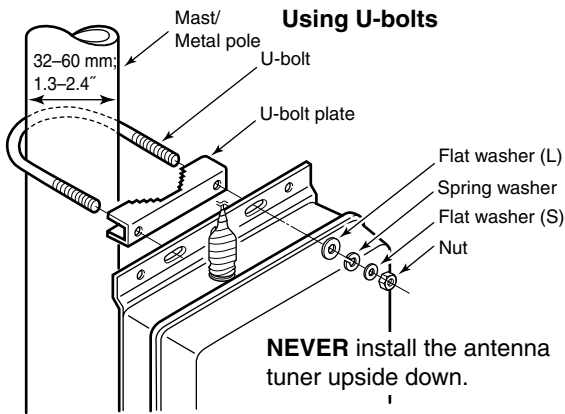

WARNING! Mount the AT-140 securely with the supplied nuts and bolts. Otherwise, vibrations and shocks due to waves could loosen the antenna tuner making it fall, causing personal injury.

◇ Mounting on a flat surface

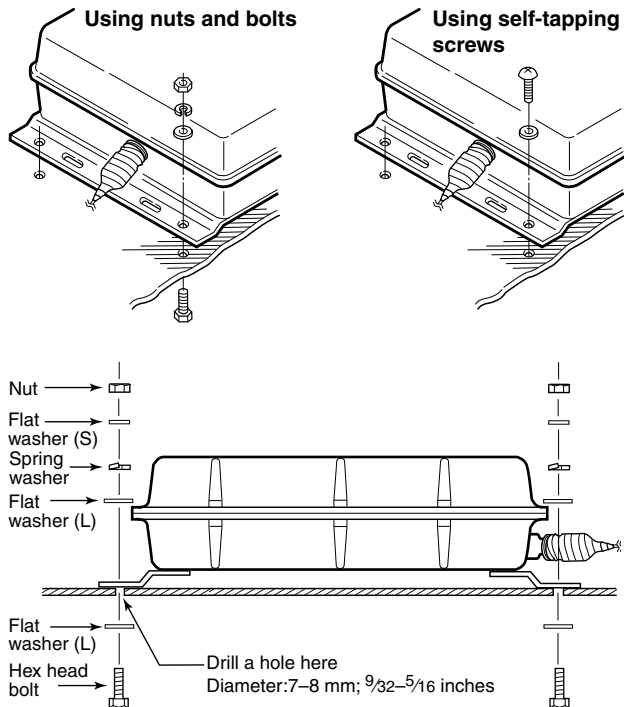

■ Cable connections

- 1 Connect the coaxial cable and the control cable to the AT-140.

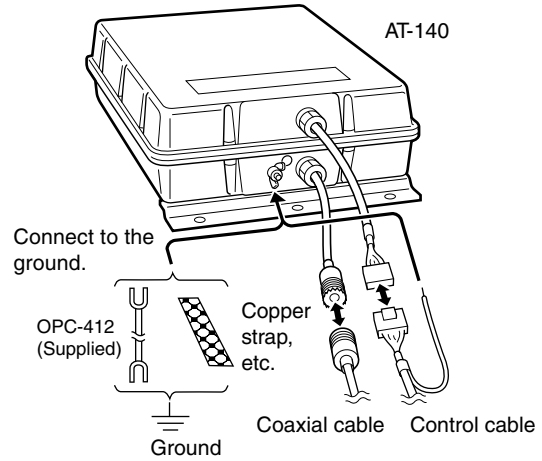

- 2 Wrap both the antenna and the control cable connectors with rubber vulcanizing tape, and then wrap electrical tape* over the rubber vulcanizing tape to secure waterproofing.

* The electrical tape is not supplied with the AT-140.

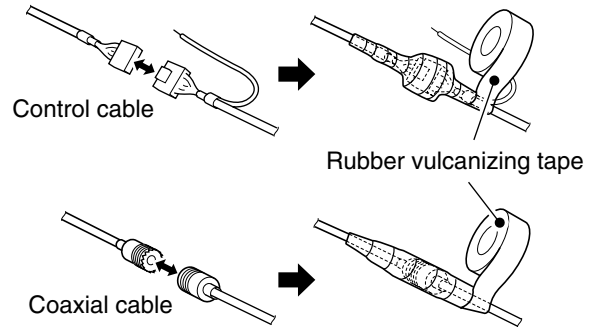

- 3 Fix both of the coaxial and control cables to protect the inside connections.

DO NOT pull the antenna and control cable receptacles. This may cause disconnection (inside the AT-140), internal connector damage or a bad connection.

- 4 Connect the coaxial cable and the control cable to the transceiver.

• See the transceiver instruction manual for details.

- 5 Ground the transceiver, AT-140 and shield cable of the control cable via the ground terminal.

• See pages 1, 2 and 4 for grounding details.

IMPORTANT:

NEVER ground the AT140 via the mounting plate. It is not connected to ground internally.

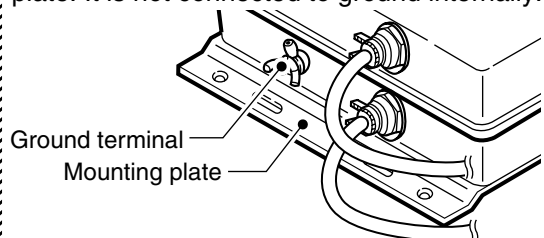

Terminal information

Terminal	Description
[KEY]	Key voltage. Grounded during tuning. Maximum current drain; 100 mA
[13.6]	13.6 V DC ⊕ input terminal. Maximum current drain; 2 A
[STAR]	Receives start voltage. Maximum current drain; 1 mA
[ANTC]	Antenna current detector output.

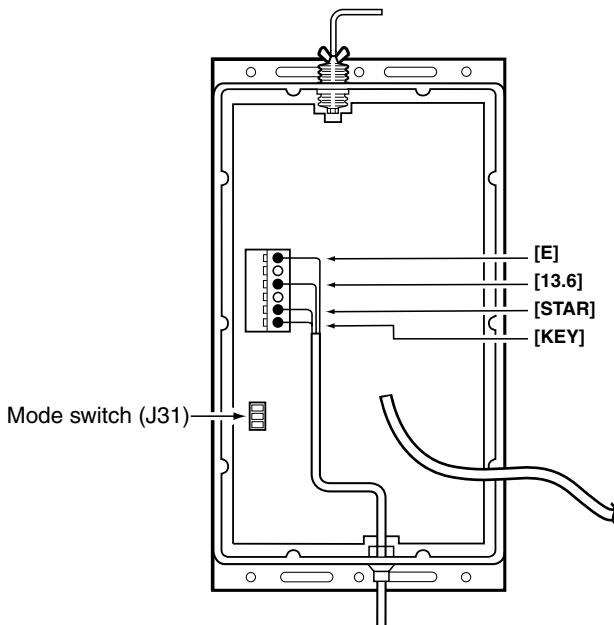
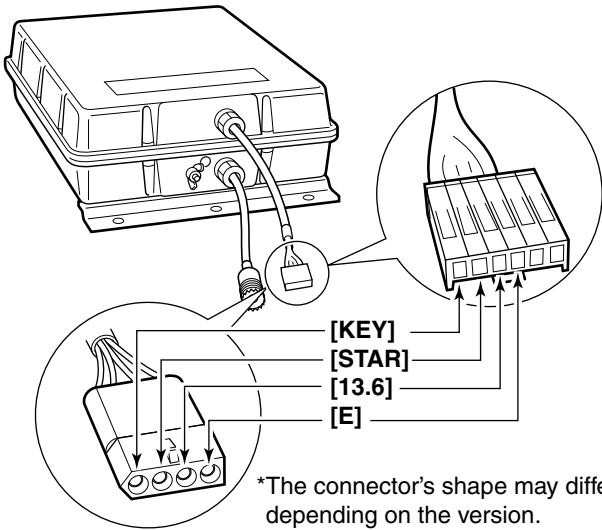

Start voltage [STAR]

When a start voltage (less than 1 V) is received, the AT-140 begins automatic tuning.

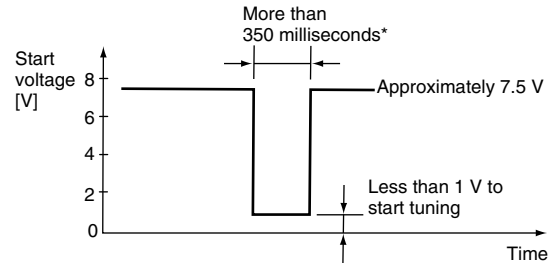

*For the Tuner Through function; Less than 250 milliseconds

Key voltage [KEY]

During automatic tuning, the AT-140 grounds the key voltage line, and the HF transceiver reduces output power.

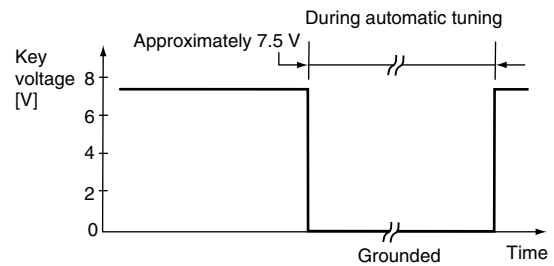

If the key voltage is more than 8 V, switch the [MODE] switch (J31) to OFF mode*.

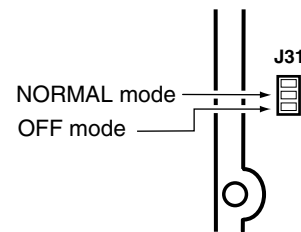

* To select a mode, insert the jumper into socket J31, according to the mode printed on the board.

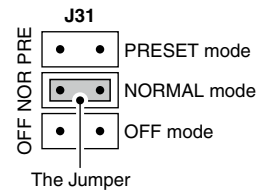

■ Transceiver setting

IC-M700 with serial number 2500 and below

In the IC-M700, change the [TUNE] switch setting from the “1” position to the “2” position. Confirm that the [KEY] switch is in the “2” position. See the IC-M700 instruction manual’s page 9 for details.

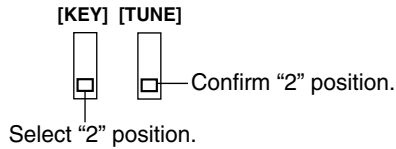

Other IC-M700 and IC-M700TY

Nothing necessary to set. However, the Tuner Through function is not available when using the AT-140 with IC-M700/TY.

IC-78

In the IC-78, select the antenna tuner type as “AH-4**” in initial set mode. See the IC-78 instruction manual’s page 32 for details.

IC-M710/RT, IC-M700PRO

In the IC-M710/RT and IC-M700PRO, select the antenna tuner type as “AH-3**” in initial set mode. See the IC-M710/RT instruction manual’s page 13 or IC-M700PRO instruction manual’s page 11 for details.

IC-M802

In the IC-M802, select the antenna tuner type as “AT-140” in initial set mode. See the IC-M802 instruction manual’s page 49 for details.

■ Unit description

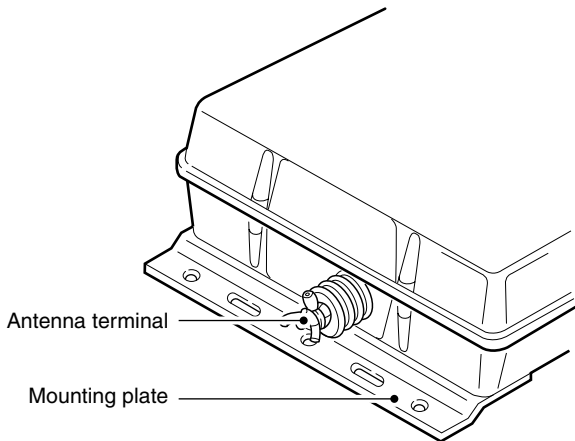
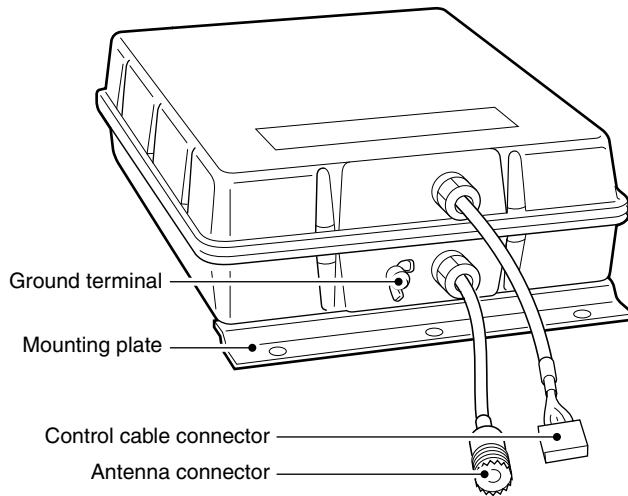

■ Dimensions

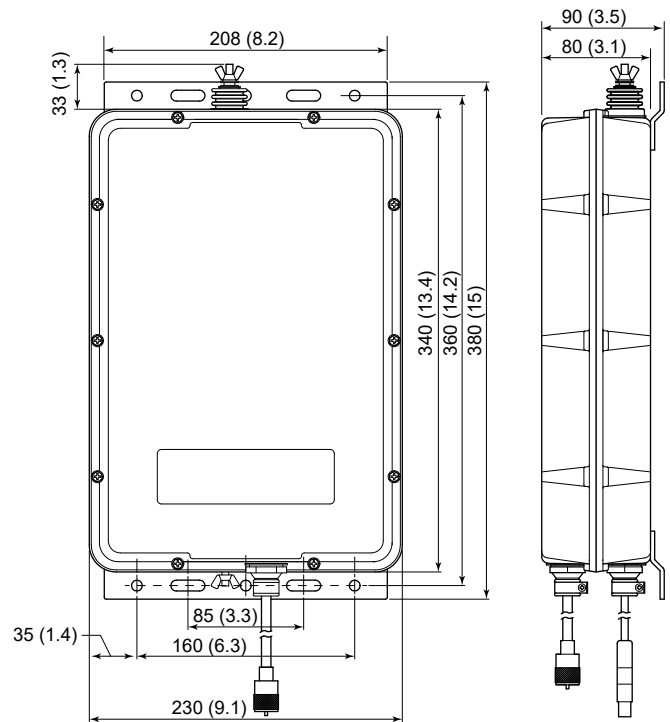

■ Specifications

- Frequency coverage: 1.6–30 MHz (With a wire antenna longer than 7 meters, and the ground terminal connected to the vessel's ground point, or a counterpoise wire longer than 7 meters.)
- Power supply requirement: 13.6 V DC \pm 15% (supplied from the HF transceiver)
- Current drain: 1.0 A or less
- Operating temperature range: -30°C to $+60^{\circ}\text{C}$ (-22°F to $+140^{\circ}\text{F}$)
- Weight (approximately): 2.5 kg; 5.5 lb
- Antenna connector: SO-239 (50 Ω)
- Maximum Input power: 150 W (PEP)
100 W (continuous)
- Automatic tuning time: Approximately 2 to 3 seconds (general condition)
Maximum 15 seconds
Approximately 1 second (re-tuning for a memorized frequency)
- Automatic tuning accuracy: SWR 2.0:1 or less (after tuning, except for multiples of $\frac{1}{2}\lambda$)
- Usable pole diameter: 32 to 60 mm; 1.3 to 2.4 inches

All stated specifications are subject to change without notice or obligation.

The following are antenna tuner and antenna installation examples for a non-sail boat. They also explain both transmission and reception performance, for your reference.

⚠ DANGER: HIGH VOLTAGE!

NEVER touch the antenna element while tuning or transmitting.

• Descriptions

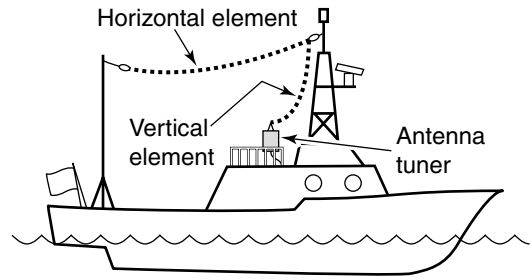

◇ Antenna tuner location versus the strength of radiation from the antenna element

The antenna tuner should be installed outside the vessel as high as possible. However, the length of the vertical element should also be as long as possible.

<p>Good — High position This antenna tuner unit position is better than others but the length of the vertical element is shorter than the others.</p>	<p>Better — Mid position This installation is also good.</p>	<p>Best — Low position This installation is perfect for the length of the vertical element and the total element length.</p>
--	---	---

◇ Style of the antenna element

When the horizontal element is longer, or made with multiple wires, the effective height of the antenna is high and communication distance may be improved.

<p>Good — Vertical This is a basic style with only the vertical element. This style is not effective for NVIS* communications.</p>	<p>Better — Inverted-L This style is a good for NVIS* and longer communications.</p>	<p>Best — Two wire inverted-L This is an even better element style than the one to the left.</p>
---	---	---

*Near Vertical Incidence Skywave. This is a radio-wave propagation method that provides usable signals in the range between groundwave and skywave distances (usually 30 to 400 miles, or 50 to 650 km).

◇ Antenna element style versus the strength of radiation from the antenna element

When the antenna tuner is installed on the deck, the following installation may be possible. The antenna element should be as long as possible, especially for the HF low band, such as the 8 MHz marine band.

<p>Good — Vertical This is a good style. The vertical element radiates waves, but the length of the element may not be enough for HF low band operation.</p>	<p>Better — Type-T The antenna effective height is much better than other styles. The higher position of the Antenna tuner provides longer communication distance.</p>	<p>Best — Inverted-L This is the best style for HF low band operation as the vertical element is long, and the total element length is also long.</p>
---	---	--

◇ **Antenna tuner location versus the strength of radiation from the same length of the antenna element**

When the antenna tuner is installed on the deck with the same element length connected.

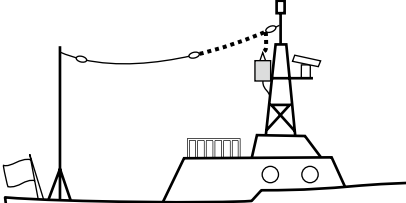
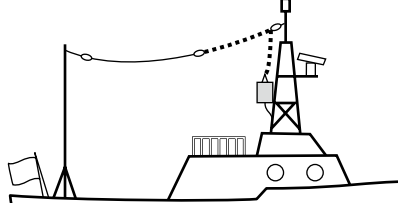
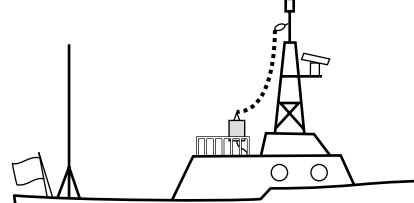
<p>Good — Horizontal The antenna tuner is installed at a higher position and the element is installed horizontally.</p> 	<p>Better — Inverted-L The element is bent in the middle as an Inverted-L antenna.</p> 	<p>Best — Vertical If the length of the antenna element is limited because of installation space, a longer vertical element will give a longer communication distance.</p> 
--	---	---

◇ **Style of the antenna element connection versus the strength of the radiation from the element**

The vertical element should be connected at the end of the horizontal element.

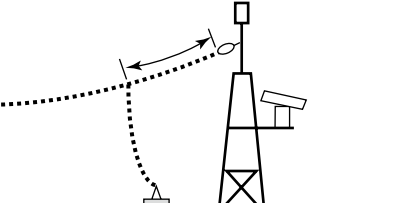
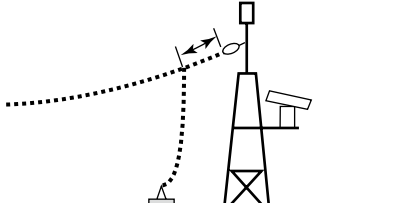
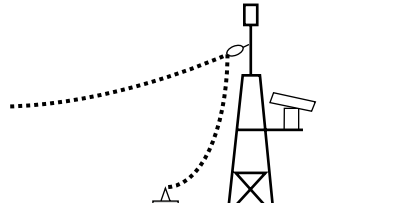
<p>Good — Long The distance is longer between the connection of the vertical element and the end of the horizontal element.</p> 	<p>Better — Short The distance between the vertical element and the end of the horizontal element is shorter, compared with the one to the left.</p> 	<p>Best — Direct The vertical element is connected directly to the end of the horizontal element.</p> 
--	---	--

◇ **Thickness of the Antenna element versus the strength of radiation from the element**

The thickness of the antenna element does not change communication quality much, but it should be as thick as possible for better radiation from the antenna element.

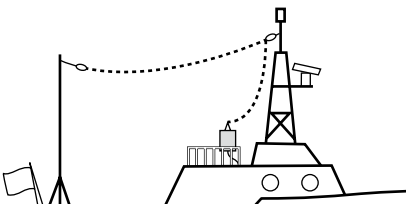
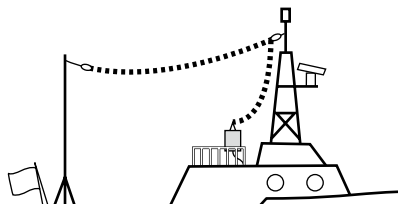
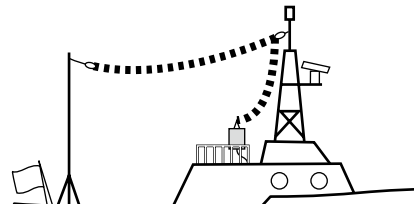
<p>Good — Regular size</p> 	<p>Better — Thick</p> 	<p>Best — Thicker</p> 
---	--	--

⚠ DANGER: HIGH VOLTAGE!
NEVER touch the antenna element while tuning or transmitting.

