

2.4/5GHz 6dBi Wi-Fi Micro Patch (H:80°/V:90°) Antenna with 4 RPSMA Plug Connectors



Ventev's 2.4/5 GHz 6 dBi Wi-Fi Micro Patch Antenna delivers outstanding Wi-Fi performance in a very small package and is ideal for space constrained environments or environments that place a premium on aesthetics. The versatile micro patch antenna is for use indoors or outdoors and is primarily designed for use with any manufacturer's 802.11ac Waves I & II access points. It can be mounted on walls or ceiling tiles, and on poles and masts using the Ventev Medium Strength Universal Mount (SKU 506048 – sold separately). The antenna is IP54 compliant to ensure outstanding outdoor performance under harsh environmental conditions.

All Ventev antennas are covered by the company's 2-year warranty.

For more information or to purchase, contact Ventev: 800.851.4965 or sales@ventev.com.

SPECIFICATIONS

- Model:** M6060060D3D3620T
- Frequency Range:** 2400~2484 / 4900~5885 MHz
- Gain:** 6 dBi
- Bandwidth:** 100 / 985 MHz
- VSWR:** 2:1 Nominal / 2:1 Nominal
- Polarization:** 2 x Horizontal, 2 x Vertical
- Front-to-Back Ratio:** 9 dBi / 15 dBi
- Impedance:** 50 Ohms
- Horizontal Beamwidth:** 80° + - 10°
- Vertical Beamwidth:** 90° + - 10°
- Power:** 20 W
- Connector:** 4 x RPSMA Plug with 3' Pigtailed
- Lead Length:** 36"
- Mounting Options:** Ceiling / Pole / Wall Mount
- Application Environment:** IP54
- Dimensions:** 4.7" x 4.7" x 1.0"
- Construction:** UV Resistant PC
- Color:** White

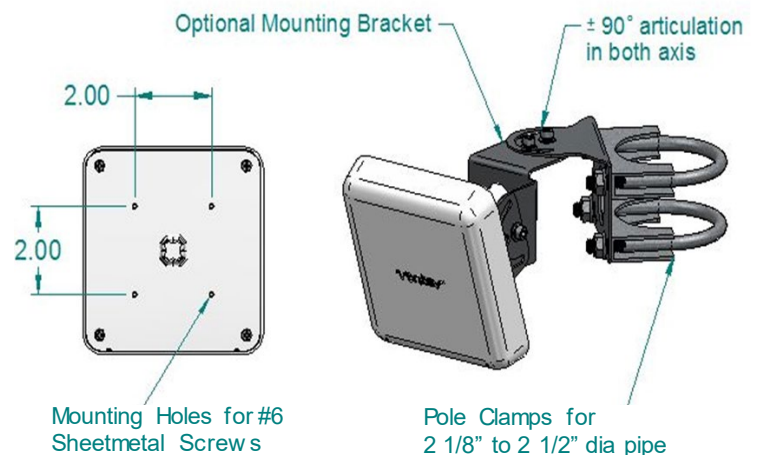
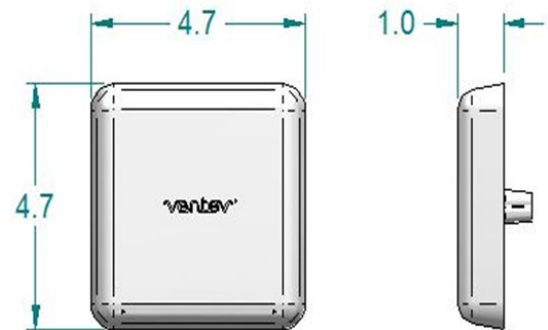

2.4/5GHz 6dBi Wi-Fi Micro Patch (H:80°/V:90°) Antenna with 4 RPSMA Plug Connectors

2400 - 2500 MHz: V Pol

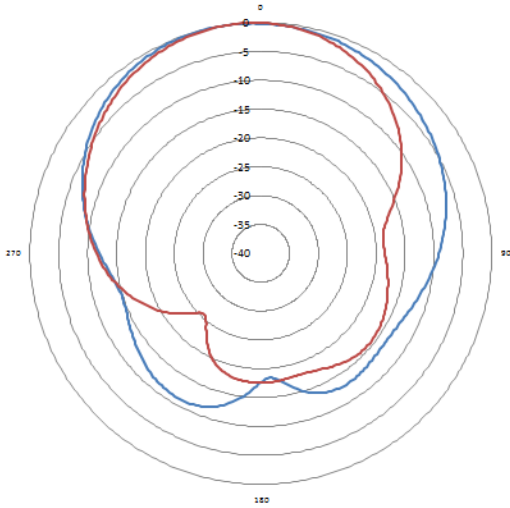

4900 - 5900 MHz: V Pol

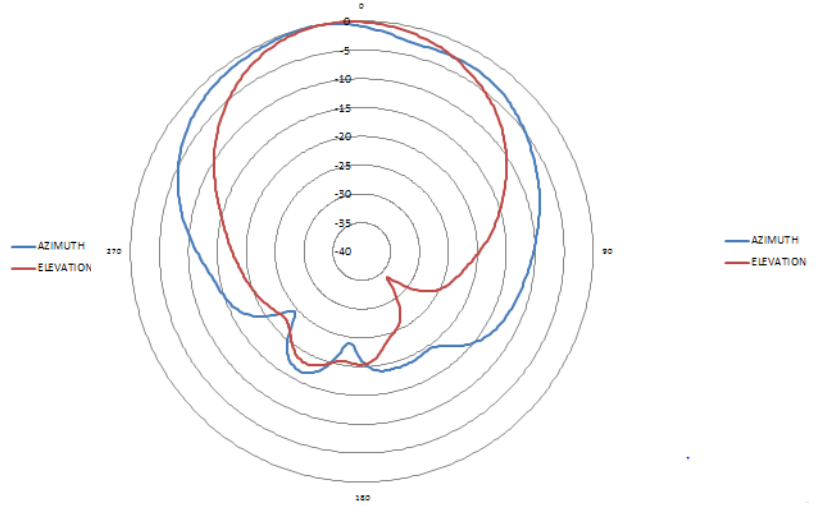

2400 - 2500 MHz: H Pol

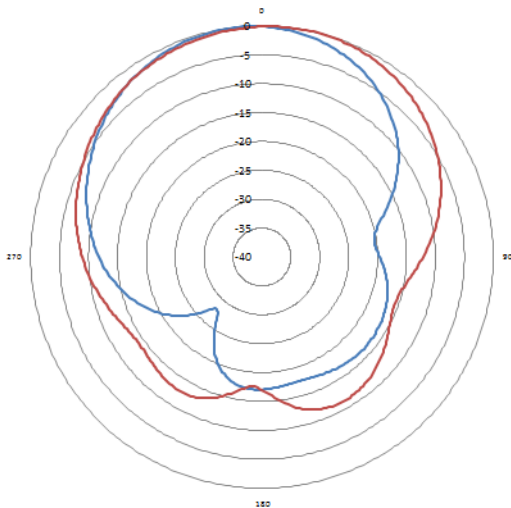

4900 - 5900 MHz: H Pol

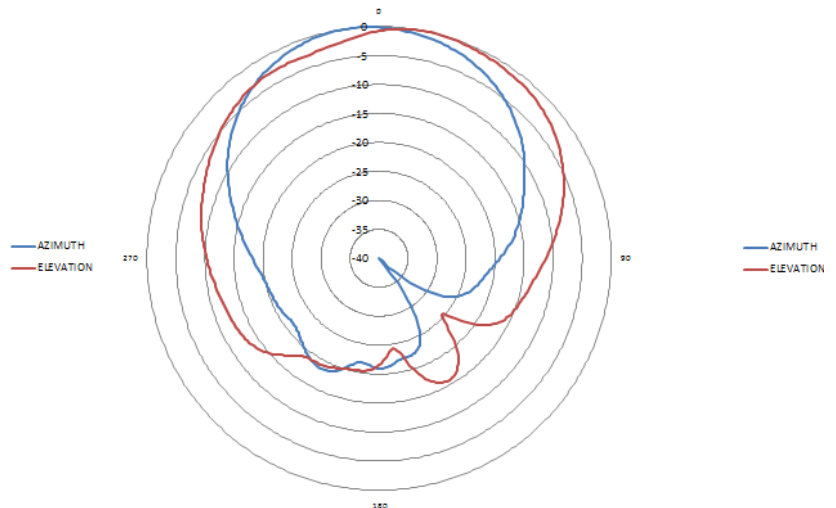

2.4/5GHz 6dBi Wi-Fi Micro Patch (H:80°/V:90°) Antenna with 4 RPSMA Plug Connectors

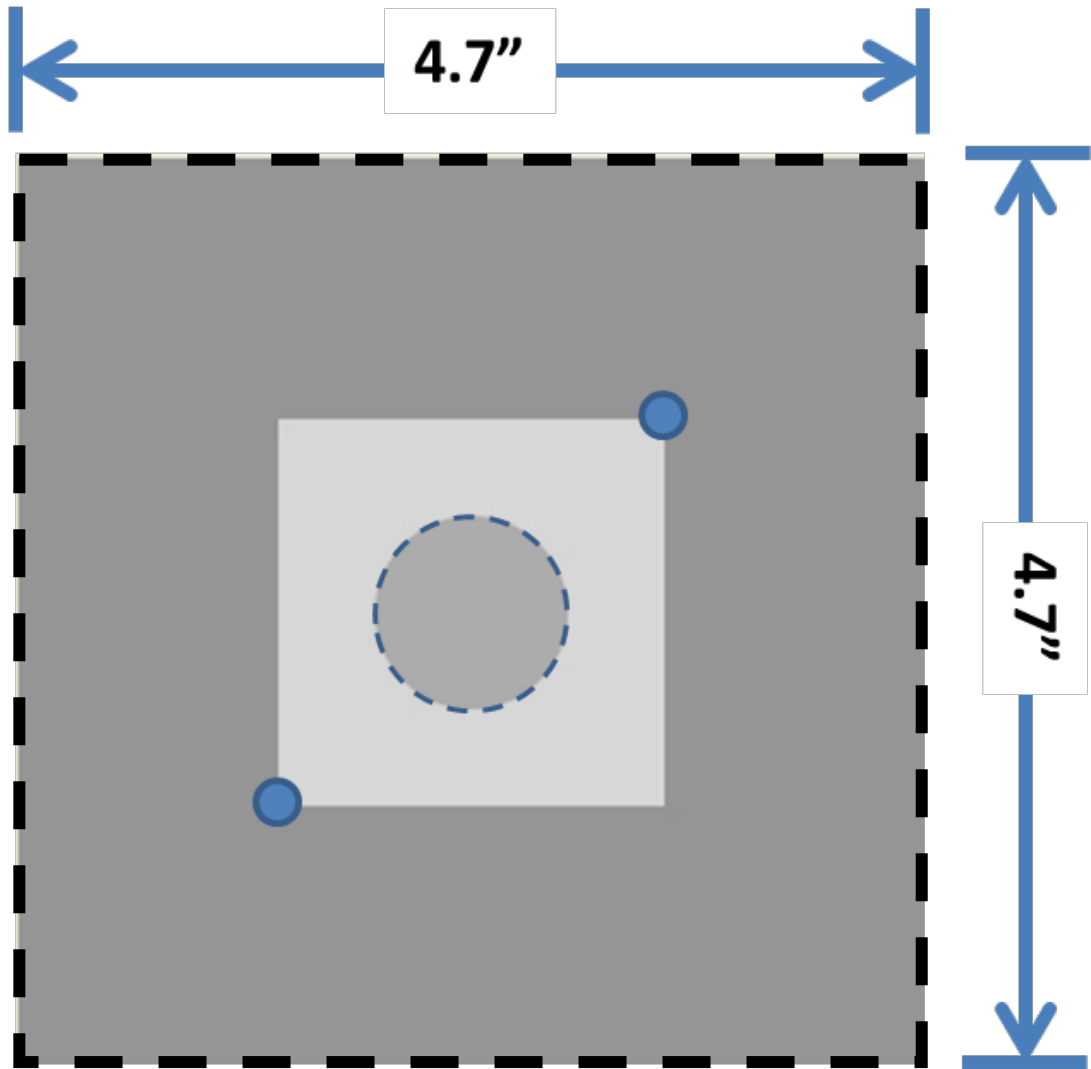

Micro Patch Mounting Instructions

1. Cut out the square template from the specification sheet by cutting around square dashed line.
2. Cut center hole out of template by cutting around circular dashed line.
3. Center the template on the ceiling-facing side of a removable ceiling tile.
4. Trace the outline of the template's center circle on the ceiling tile. Note: The antenna's leads will be fed through this hole during mounting.
5. Punch holes into the two blue circles and into the ceiling tile at two opposite corners of the template using a nail or other pointed tool. Note: These two holes will be used to insert screws into the back of the antenna and will secure antenna to ceiling tile.
6. Remove the template from the ceiling tile.
7. Drill the center hole in the ceiling tile using a 1" diameter drill bit.
8. Drill the two mounting holes using a 1/4" drill bit.
9. Place the antenna on the downward facing side of the ceiling tile and feed the antenna leads through the ceiling tile's center hole. Ensure the mounting holes on the back of the antenna align with the 1/4" drilled holes.
10. Insert the two mounting screws through the two mounting screw holes and screw into the back of the antenna.

Note: Perform this step gently; ensure the screw tips align with/ enter the holes on the back of the antenna.